

# TriWay®

TibioTaloCalcaneal (TTC) Arthrodesis System

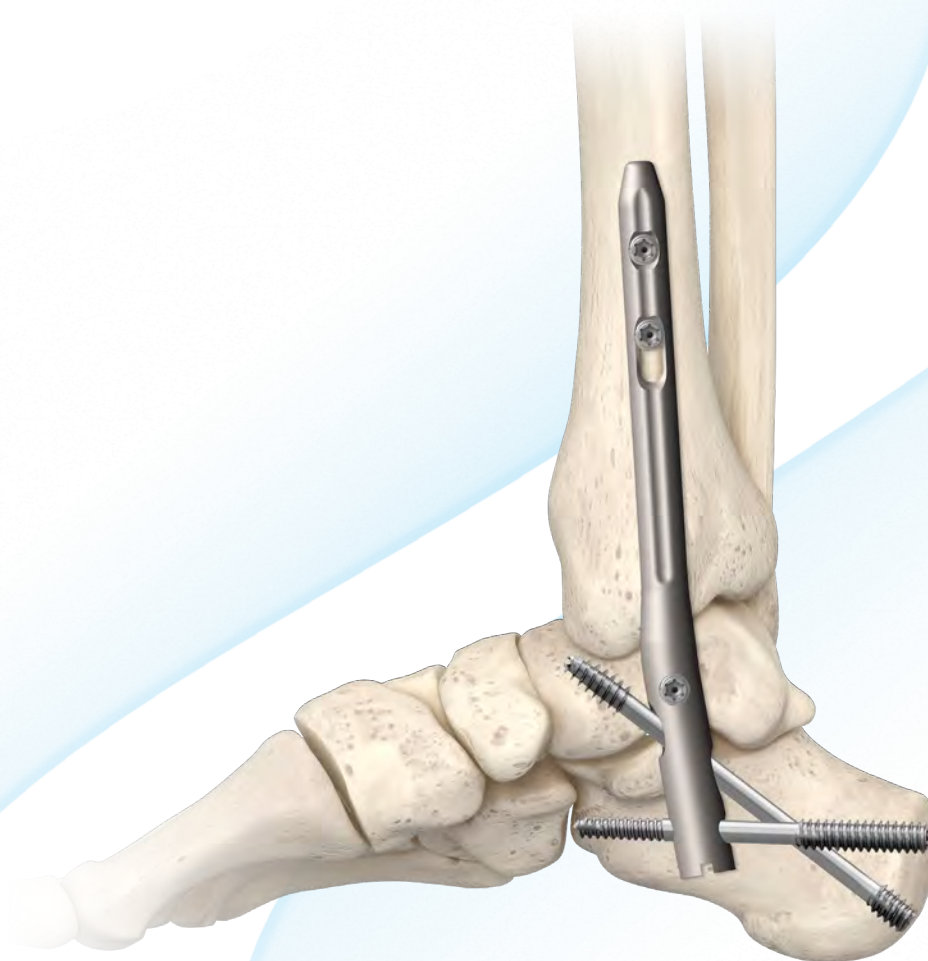

Solid Nail Construct  
Multi-planar Fixation  
Anatomical 7° Posterior Offset Nail



A GLOBAL EXTREMITY COMPANY

# TABLE OF CONTENTS

Indications / Contraindications.....	2
System Overview / Specifications .....	3
Instrumentation Design Features .....	3
Surgical Technique Overview	
Distal Screws First.....	5
Proximal Screws First.....	6
Surgical Technique	
Patient Positioning / Bone Prep	
Anterior Approach .....	7
Trans-fibular Approach .....	8
Plantar entry point.....	9
Guide Wire insertion .....	9
Intramedullary bone preparation.....	10
Targeting Jig assembly.....	11
Nail Fixation and Compression	
Distal Screws placement first.....	13
Subtalar Compression Screw	
Anterior approach.....	15
Posterior approach.....	16
Talar Screw placement .....	17
Tibio-Talar Joint Compression .....	18
Proximal Screw placement .....	18
Proximal Screws placement first.....	21
Closing and postoperative protocol .....	22
Revision technique.....	22
Ordering information.....	23
Implants	
Instruments	
Regulatory information.....	24

## INDICATIONS

The TRIWAY® Nail Ankle Arthrodesis System is intended for use in tibiotalocalcaneal arthrodesis and treatment of trauma to the hindfoot and distal tibia. Examples include:

- Post-traumatic and degenerative arthritis involving both ankle and subtalar joints
- Rheumatoid arthritis with severe deformity
- Revision of failed ankle arthrodesis with subtalar involvement or with insufficient talar body
- Revision of failed total ankle arthroplasty with subtalar intrusion
- Talar deficiency conditions, including avascular necrosis (requiring a tibiocalcaneal arthrodesis)
- Neuropathy or neuromuscular deformity or other neuromuscular disease with severe deformity or instability of the ankle, including Charcot foot
- Severe pilon fractures with trauma to the subtalar joint
- Malunited tibial pilon fractures

The addition of an IBS® 6.5mm Compression Screw through the subtalar joint and through the Nail is required.

## CONTRAINDICATIONS

The implant should not be used in a patient who has currently, or who has history of:

- Acute or chronic, systemic inflammations,
- Active infections,
- Sensitivity/allergies to the implant materials.
- Bone pathologies that may compromise the rigidity of the implant fixation (examples include: osteoporosis, acute cystic developments, acute osteopenia, bone tumor, etc...)

In2Bones® as the manufacturer of this device, does not practice medicine. The surgeon who performs any implant procedure is responsible for determining and using the appropriate surgical techniques for implanting the device in each patient. This Surgical Technique Manual is furnished for information purposes, as an aid to properly use the device and its dedicated instruments.

# TriWay<sup>®</sup> TibioTaloCalcaneal Arthrodesis System

## SYSTEM OVERVIEW / SPECIFICATIONS / DESIGN RATIONALE

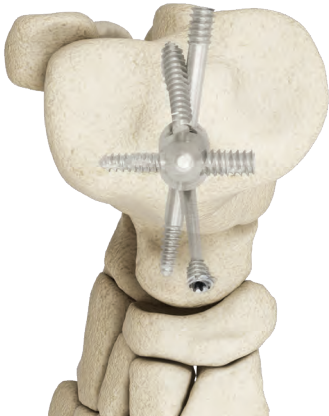

### IMPLANT SPECIFICATIONS

#### Solid Nail Construct

#### Multi-planar fixation

- Medio-lateral fixation
- Postero-anterior fixation
- Oblique screw in subtalar joint line with a slight valgus to match subtalar anatomical alignment

#### 7° posterior offset Nail to calcaneocuboid joint line

- Designed for increased purchase in the calcaneus
- Straight Nail philosophy for bone preparation surgical steps

#### Anatomical Design

- Right & left versions
- 3 diameters (10-11-12mm)
- 3 lengths (160-200-250mm)

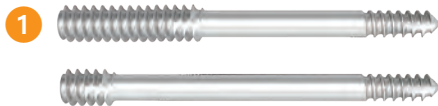

### SCREWS DESIGN RATIONALE

#### 1 5.0 mm Cotter Screws

- Available in 25mm to 90mm lengths, 5mm increments
- For tibia, talus and calcaneus fixation
- Solid construct and works as a rod and allows for adequate fixation in bone
- No screw head impingement
- No screw thread / Nail impingement

#### 6.5mm IBS C & C+ Screws

- Can be placed either with an anterior or posterior approach
  - Compression screw provides subtalar compression
  - When distal screws are placed first, there is no need to anticipate compression effect upon final position of the Nail
- 2 • 6.5mm IBS C Screws: distal thread is 15mm long and is recommended when subtalar screw is preferred from posterior approach
- 3 • 6.5mm IBS C+ Screws: distal thread is 30mm long and is recommended when subtalar screw is preferred from anterior approach



# TriWay® TTC Arthrodesis System

## INSTRUMENTATION DESIGN FEATURES

### Independent Subtalar Compression Screw

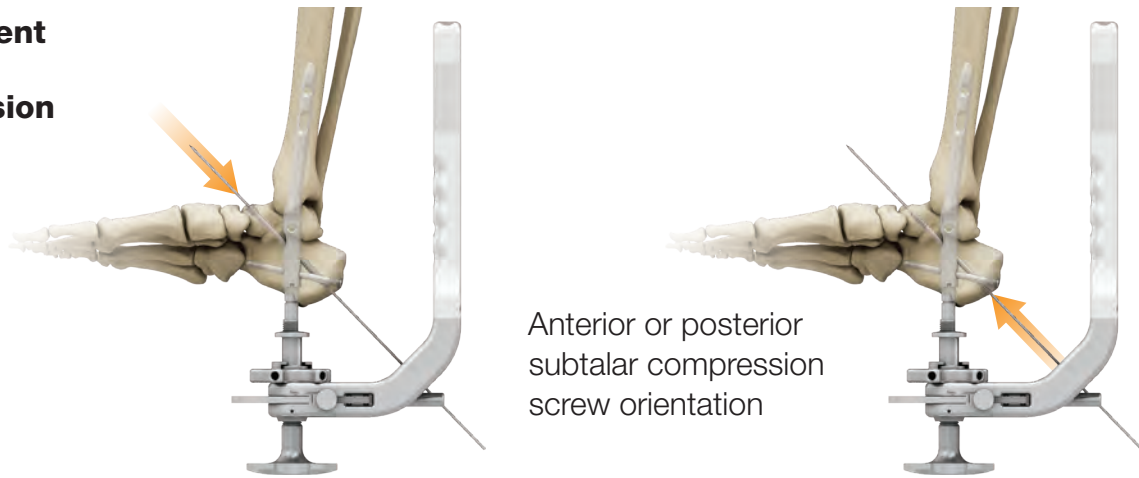

Anterior or posterior subtalar compression screw orientation

### Variable Compression

- when proximal screws are inserted first

Up-to 35mm of external compression

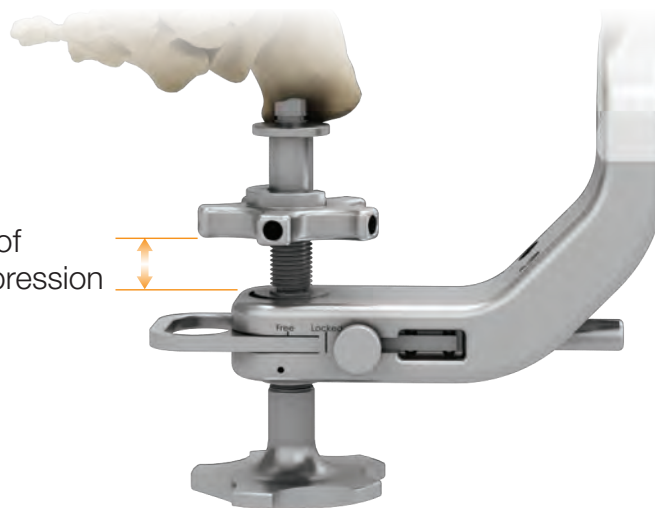

### Streamlined Instrumentation

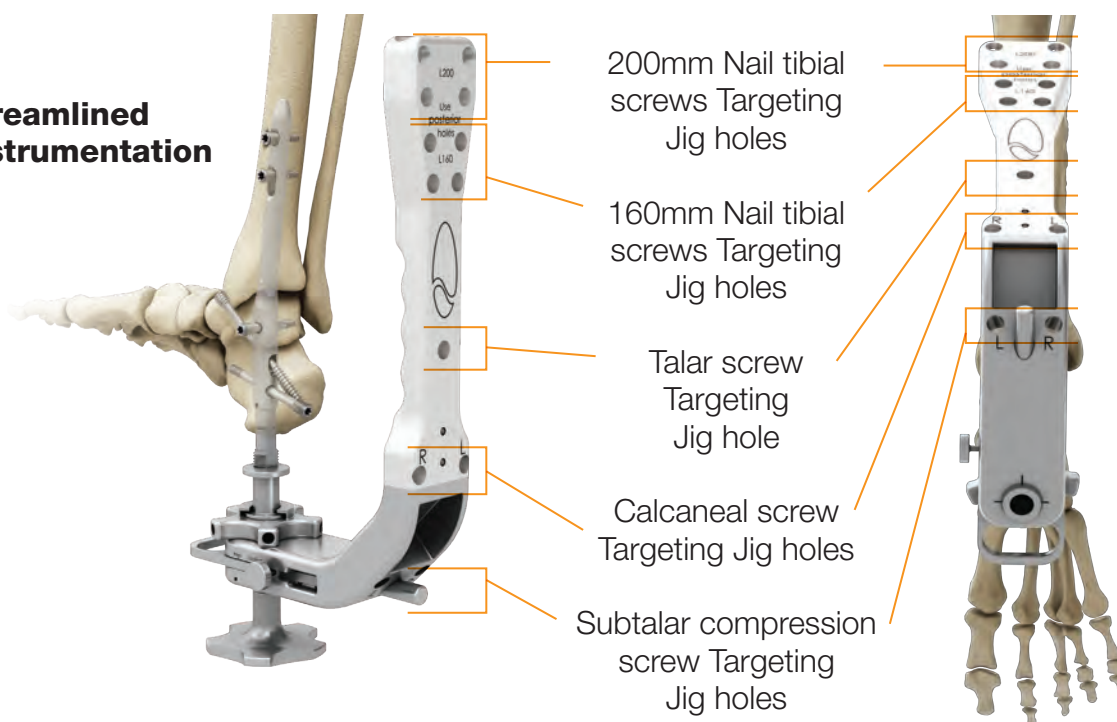

200mm Nail tibial screws Targeting Jig holes

160mm Nail tibial screws Targeting Jig holes

Talar screw Targeting Jig hole

Calcaneal screw Targeting Jig holes

Subtalar compression screw Targeting Jig holes

# SURGICAL TECHNIQUE OVERVIEW...with **Distal Screws First**

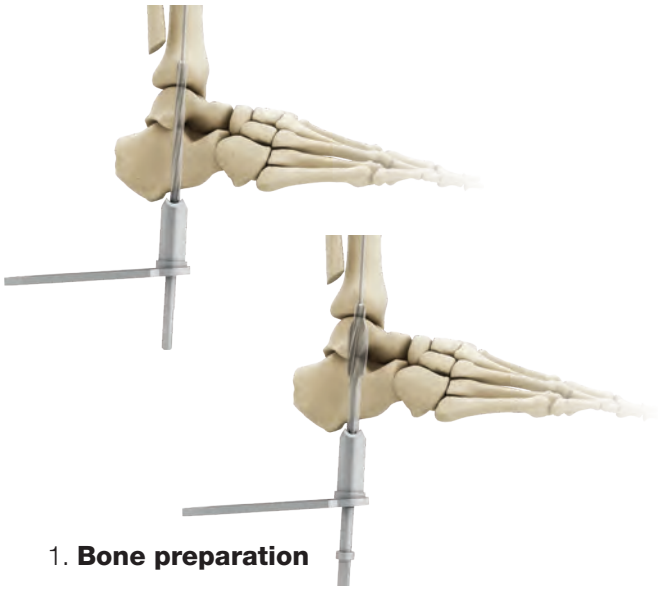

1. **Bone preparation**



2. **Targeting Jig assembly**



3. **Nail insertion**

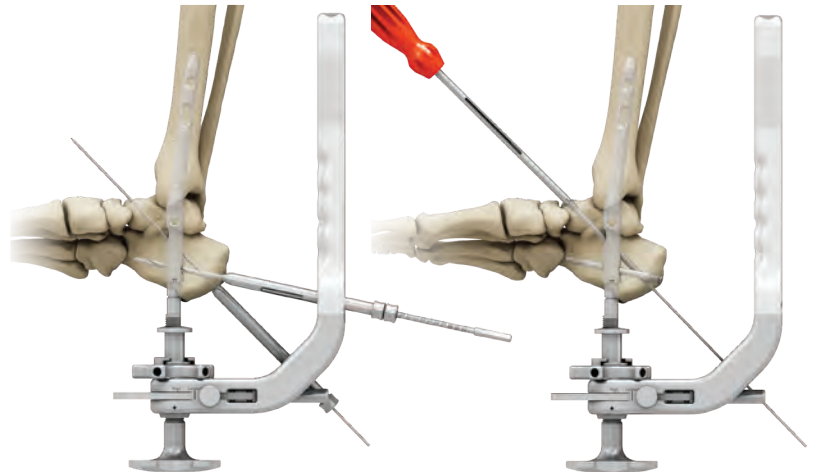

4. **Distal screws insertion**



5. **Compression**

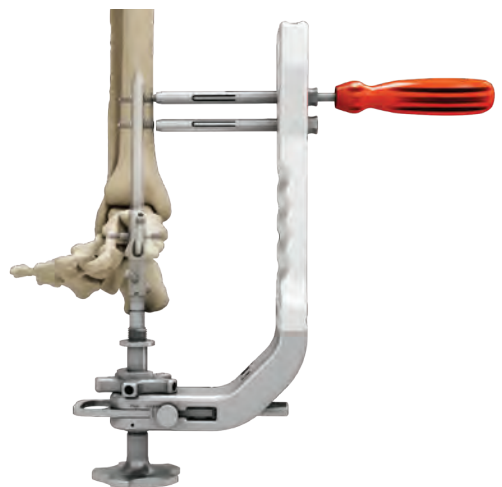

6. **Proximal screws insertion**

# TriWay® TTC Arthrodesis System

## SURGICAL TECHNIQUE OVERVIEW... with **Proximal Screws First**

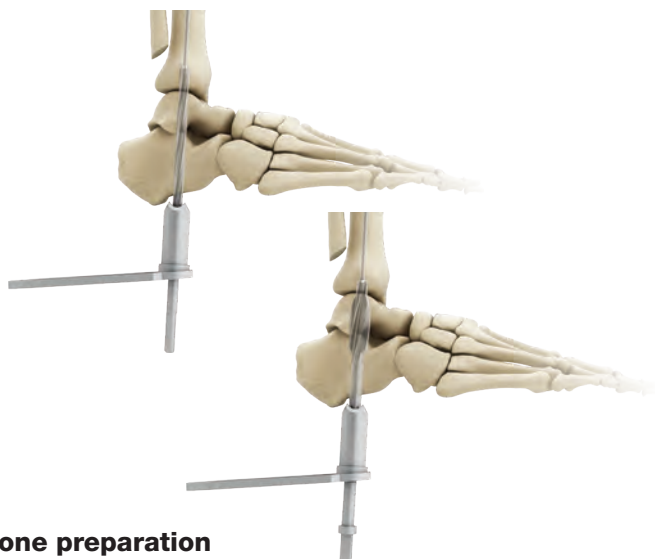

1. **Bone preparation**



2. **Targeting Jig assembly**



3. **Nail insertion**



4. **Proximal fixation**

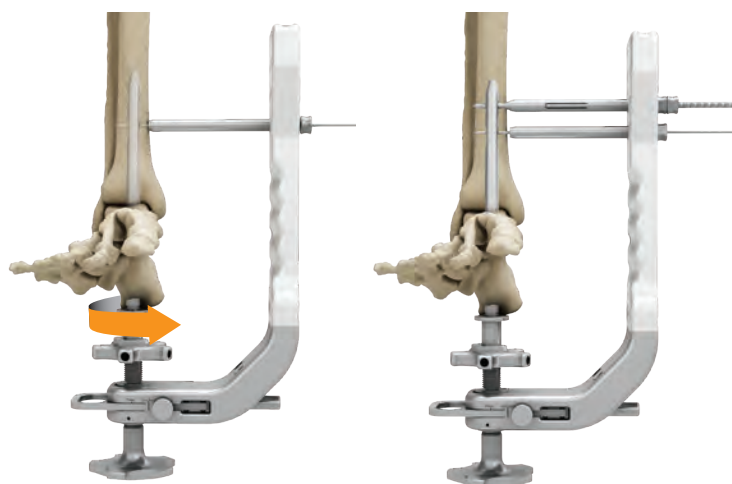

5. **Compression and proximal screws insertion**

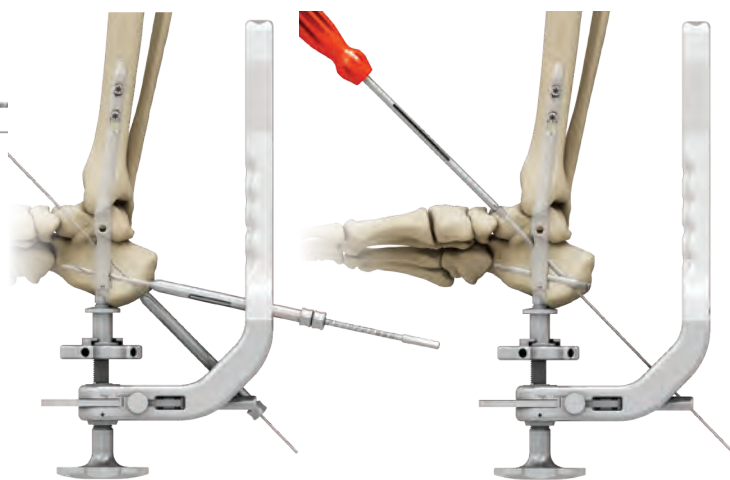

6. **Distal screws insertion**

# SURGICAL TECHNIQUE: **Anterior Approach**



## **1. Patient Positioning and Bone Preparation with Anterior Approach**

If an anterior approach is preferred, patient can be placed in supine position on the operating table.

### **SUPINE PATIENT POSITIONING**

The patient is placed in the supine position on a radiolucent operating table with the affected extremity elevated in neutral alignment. If the surgeon wishes to insert the subtalar compression screw with an anterior approach, this is the preferred position. General or spinal anesthesia is required and a thigh tourniquet is used.

### **SURGICAL EXPOSURE**

An anterior incision is performed at the tibiotalar joint line level. Care should be taken with neurovascular structures and tendons.

A lateral approach is done in the sinus tarsi area to access the subtalar joint.



### **BONE PREPARATION**

Osteophytes and cartilage are removed from the tibiotalar joint line with the use of curette, chisel, bone rongeur or sawblade, according to surgeon preference.

The Tibio Talar Cutting Guide (N02 00023) can be used to perform parallel cuts over the tibiotalar joint line. Place the Cutting Guide block over the joint line and the 2.5x200mm K-wire (K10 NS200) into the proximal part of the Guide to align the Guide over the tibial axis. Once the Guide is well positioned, fix the Guide on the tibia and on the talus with 4 2.5x100mm K-wires (K10 NS251). Perform the tibial and talar parallel cuts with the use of a sawblade directly within the Guide slots. Remove the Guide once the cuts are completed and remove bone fragments.

The subtalar joint line is also prepared to ensure proper subtalar fusion.

# TriWay® TTC Arthrodesis System

## SURGICAL TECHNIQUE... with **Trans-fibular Approach**

### 2. Patient Positioning and Bone Preparation with Trans-fibular Approach

If a trans-fibular approach is preferred, patient can be positioned in the lateral position on the operating table. If a supine position is preferred, please refer to the supine position description page.



#### LATERAL PATIENT POSITIONING

The patient is positioned in the lateral decubitus position on a radiolucent operating table with the affected extremity accessible. If the surgeon wishes to address the subtalar compression screw with a posterior approach, this is the ideal position. General or spinal anesthesia is required and a thigh tourniquet is used.

#### SURGICAL EXPOSURE

A curvilinear incision is made over the fibula, curving distally along the peroneus tendon. Care should be taken with neurovascular structures and tendons. The incision is then extended distally to the sinus tarsi area to visualize the subtalar joint and facilitate access for bone preparation.



#### FIBULA RESECTION

The distal part of the fibula is removed in an oblique fashion in order to expose the tibiotalar and the subtalar joints lines. The distal part of the fibula shall be used either for bone graft, or shall be repositioned at the end of the procedure to reproduce the mortise of the ankle joint.

#### BONE PREPARATION

Osteophytes and cartilage are removed from the tibiotalar joint line with a curette, chisel, bone rongeur or sawblade, according to surgeon preference. The subtalar joint line is also prepared to ensure good subtalar fusion.





# SURGICAL TECHNIQUE



### 3. Plantar Entry Point

The plantar entry point is visually localized with a K-wire placed in the tibial axis and in the alignment of the second ray. Due to the posterior offset design of the implant, the entry point is moved 3 to 5mm posteriorly. A longitudinal incision, approximately 2–3cm should be made at this intersection. Careful dissection is then utilized to gain access to the plantar surface of the calcaneus.



### 4. Guide Wire Insertion

Insert the 3.2x350mm Guide Wire (N02 00014) through the center of the lateral column of the calcaneus up to the center of the talar dome.

Once the 3.2x350mm Guide Wire is located in the center of the talar dome, care must be taken to position the ankle in 5° dorsiflexion before Guide Wire insertion in the tibial canal shaft. Insert the Guide Wire in the tibia.

Confirm the Guide Wire position with a C-Arm. Guide Wire must be aligned with the talar lateral process.

 Take care to position the ankle in 5° dorsiflexion to avoid equinus position after Nail insertion.

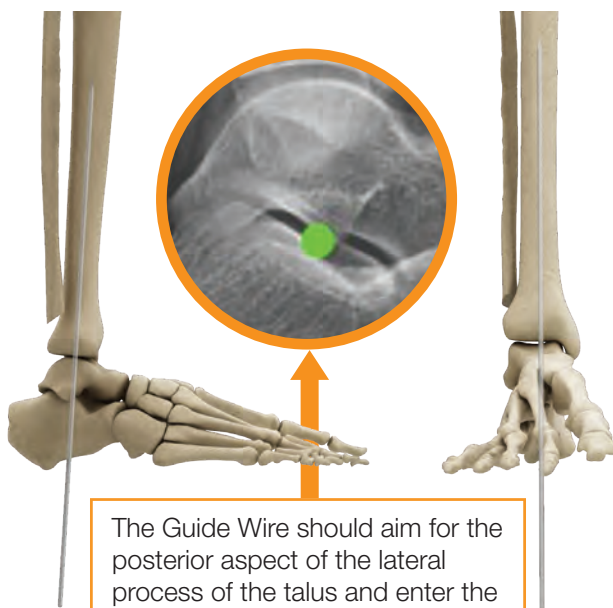

The Guide Wire should aim for the posterior aspect of the lateral process of the talus and enter the distal tibia just anterior to the mid point of the tibial canal.

# TriWay® TTC Arthrodesis System

## SURGICAL TECHNIQUE

### 5. Calcaneal, Talar and Tibial Bone Preparation

Place the Soft Tissue Protector (N02 00006) over the 3.2x350mm Guide Wire (N02 00014) to avoid any soft tissue impingement. Insert the 7.0mm cannulated Drill (N02 00027) over the Guide Wire until the laser marking is aligned with the base of the Soft Tissue Protector.

Remove the 7.0mm cannulated Drill. Take care to keep the 3.2mm Guidewire in place during the removal process. Insert the 14.0mm Reamer (N02 00016) over the 3.2mm Guidewire. Use the Soft Tissue Protector to avoid any soft tissue impingement. Ream until the laser marking is aligned with the base of the Soft Tissue Protector.

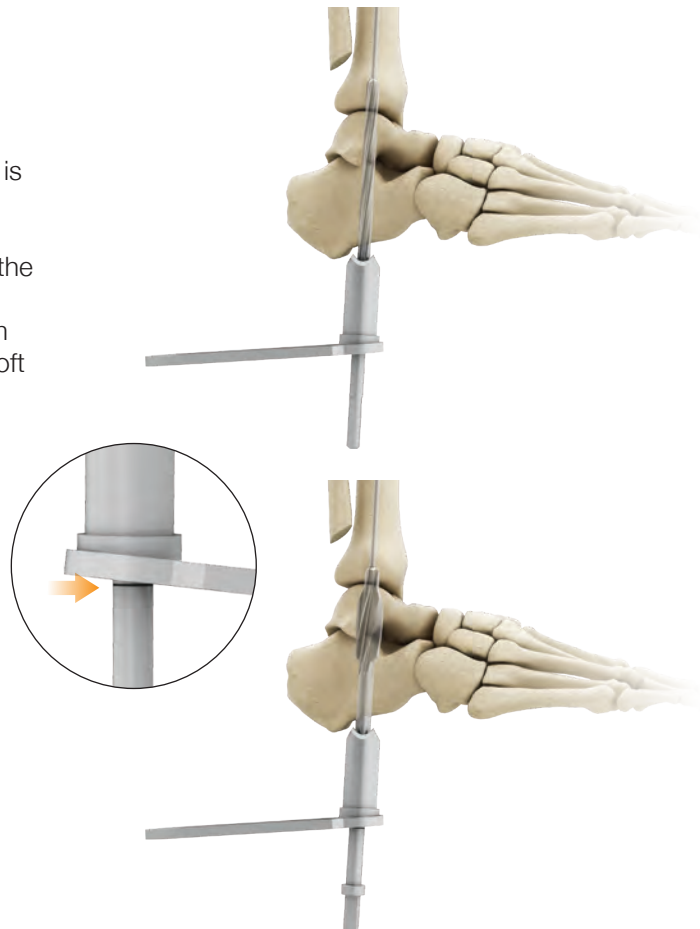

### TIBIAL CANAL REAMING

Tibial canal must be prepared with cannulated flexible Reamers. Cannulated flexible Reamers can be provided upon request by In2Bones as an option to the general instrument set.

 Be sure to follow manufacturer's recommendation while using the flexible Reamers.

Ream the tibial canal 1mm above the desired Nail diameter size. Nail diameter and length will be selected according to surgeon preference.

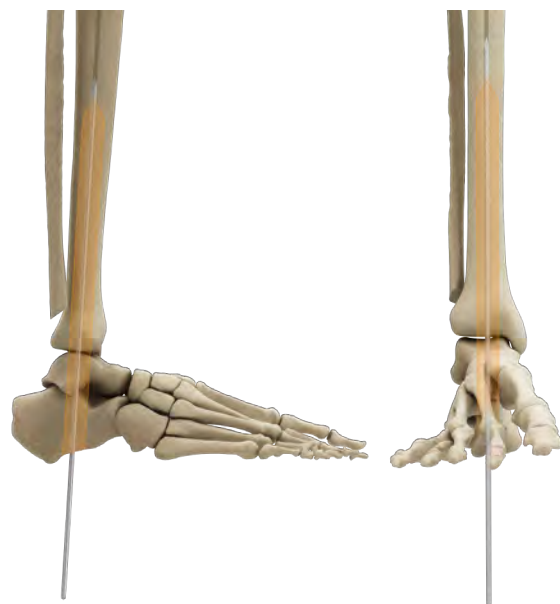

## 6. Targeting Jig Assembly

Screw in the Index Lock (N02 00020) into the Index Tab (N02 00005) until its threads appear in the index tab window.

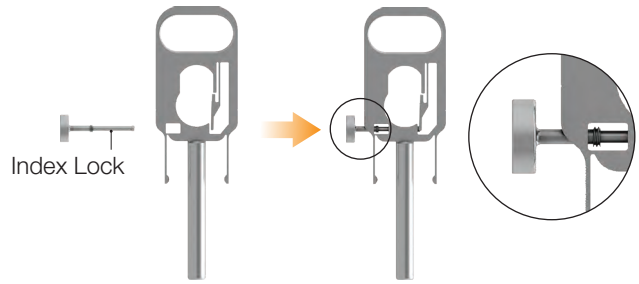



Slide the Index Tab, cylindrical part first, into the Targeting Jig (N02 00001) until the mark on the Index Tab is placed in "Free" position in the Guide.



Engage the Compression Sleeve (N02 00010) into the Compression Wheel slot (N02 00009) with the domed surface up.



 Align the flat surfaces of the Compression Sleeve and the Connector (N02 00003) facing up.

 Screw the Sleeve and the Connector together. Make sure the flat surfaces face up during this step.

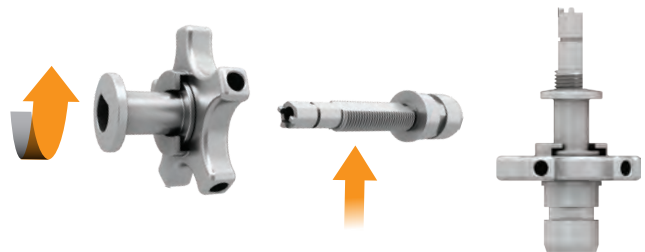

Attach the Nail assembly to the Connector and lock the Fixation Screw (N02 00004) with the non cannulated T25 Screwdriver (G01 01641).

The Nail must be tightened firmly.

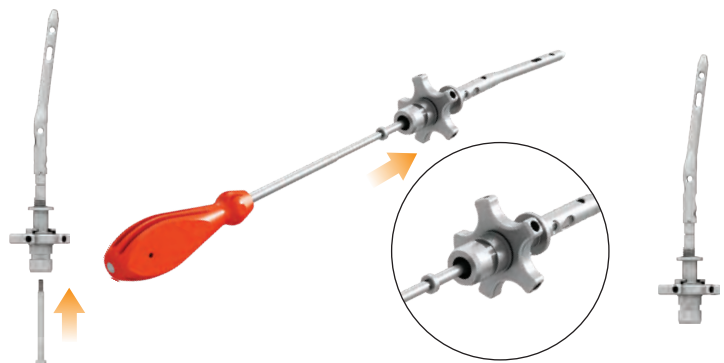

Insert the Nail assembly within the Targeting Jig. Make sure the Index Tab is in the "Free" position.

- A.** Push and maintain the Index Lock.
- B.** Place the Nail assembly within the Index Tab/Targeting Jig as shown.
- C.** Pull up slightly on the Nail assembly until a visible and audible click of the Index Tab is noticed to confirm proper alignment.

 After the assembly, the Compression Wheel should be near the bottom of the Jig.

 Confirm that the Nail is angled toward the Jig.

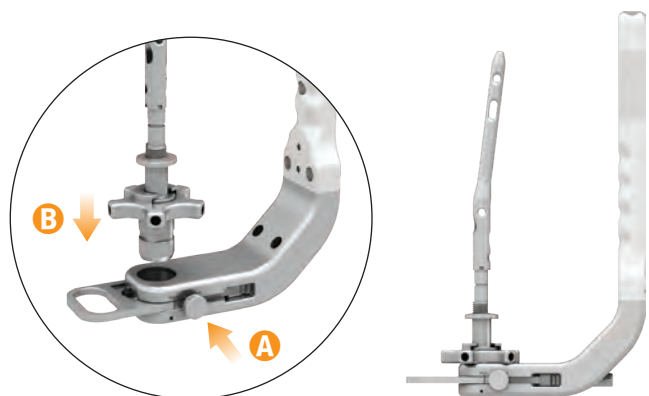

# TriWay<sup>®</sup> TTC Arthrodesis System

## SURGICAL TECHNIQUE

To lock, push the Index Tab in the Targeting Jig until the "Locked" position is reached with the Index Tab.

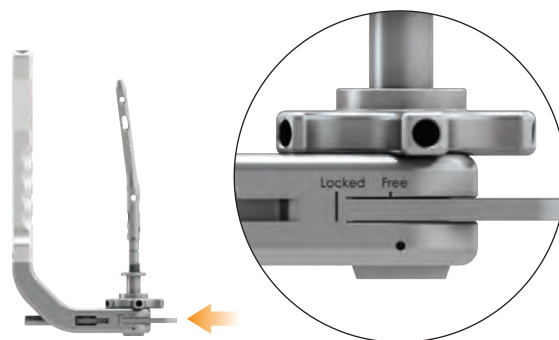

To modify the Nail position, pull the Index Tab until the line faces "Free" on the Targeting Jig.

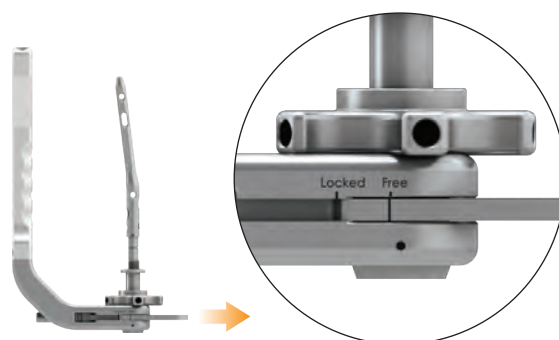

Rotate the Nail by 1/4 of a turn to obtain the desired position

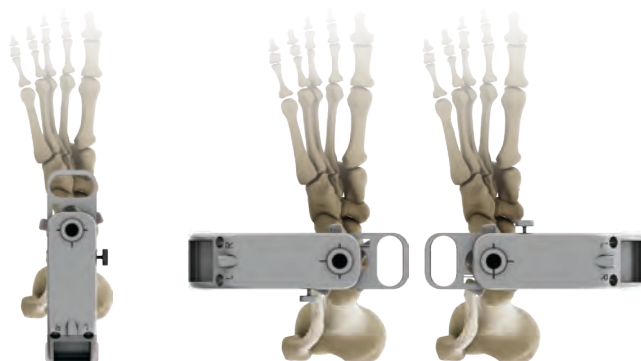

POSTERIOR POSITION

LATERAL AND MEDIAL POSITION

**A.** Push the Index Tab back into "Locked".

**B.** Screw the Hitting Plate (N02 00011) onto the Targeting Jig.

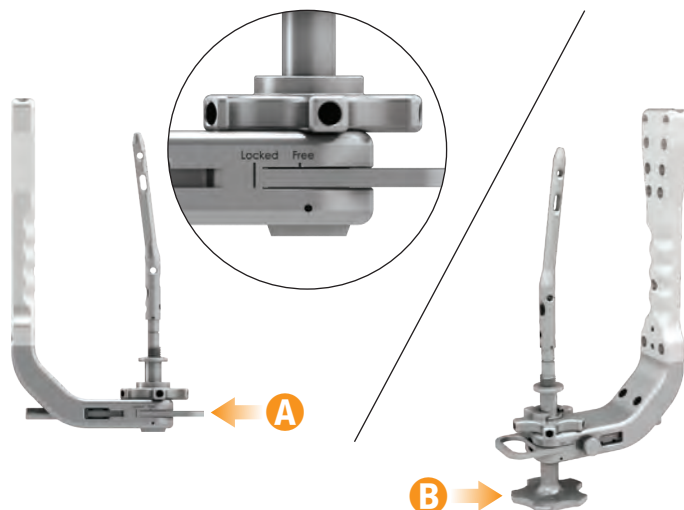

## 7. Nail Fixation and Compression with Distal Screws First

### NAIL INSERTION

Make sure the 3.2x350mm Guide Wire is removed before inserting the Nail.

Place the Nail in the back position on the Targeting Jig with the Index Tab on the "Free" position, by aligning the Targeting Jig arm with the back position as illustrated.

 Lock the position by pushing the Index Tab to the "Locked" position.

The Nail is introduced manually in the prepared bone surfaces through the plantar incision. Confirm the insertion depth with fluoroscopy.

A radiopaque demarcation is visible to visualize the distal part of the Nail. Be sure the Nail's distal part is flush to the calcaneus plantar aspect. If needed, the Nail can be further impacted with a mallet on the Hitting Plate or with the Slap Hammer Guide (N02 00024) and the Slap Hammer Mass (N02 00025) assembled and threaded into the Hitting Plate.

Confirm the final positioning of the Nail with fluoroscopy.

### DISTAL SCREWS INSERTION

Insert the Protecting Sleeve (N02 00013) and the Drill Guide (N02 00007) into the calcaneus screw hole of the Targeting Jig. Insert the K-wire Guide (N02 00008) into the subtalar screw hole of the Targeting Jig.

### SUBTALAR SCREW PREPARATION

Insert the 2.0x300mm K-wire (N02 00017) into the K-wire Guide until the K-wire protrudes from the talar neck.

 Make sure to select the appropriate hole of the Targeting Jig, according to the operative side.

 Make sure that the Sleeve and Drill Guide are in contact with the bone for accurate measurement.

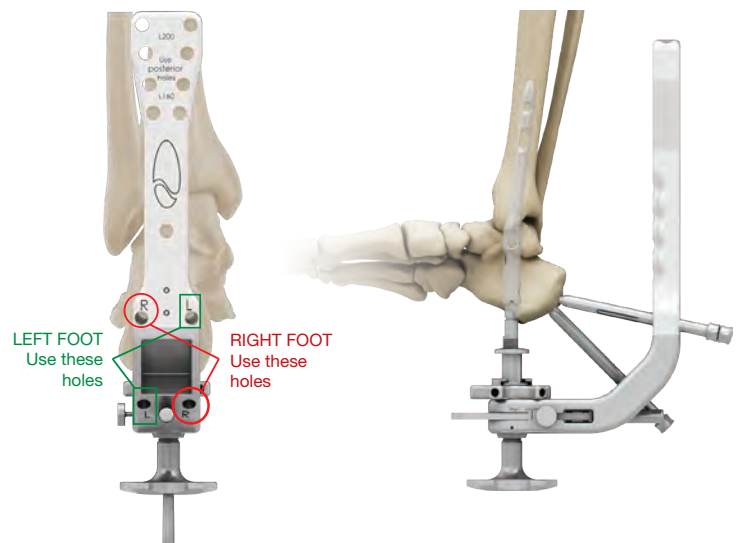
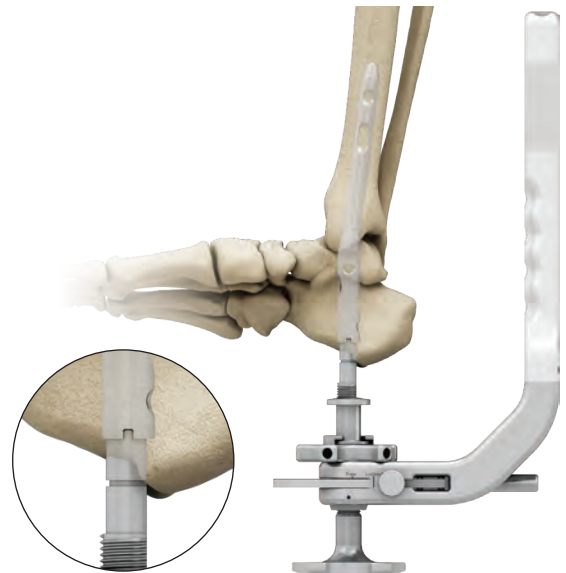
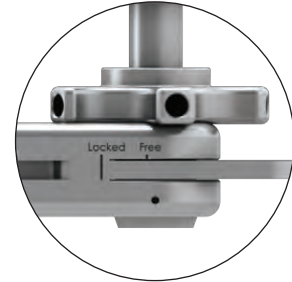
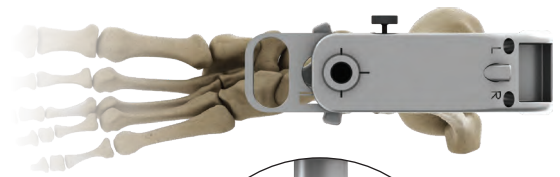

# TriWay® TTC Arthrodesis System

## SURGICAL TECHNIQUE

### CALCANEAL SCREW INSERTION

Insert the Trocar Tip (N02 00026) into the Protecting Sleeve and Drill Guide and puncture the calcaneus cortical wall by impacting the Trocar Tip with a mallet. Remove the Trocar Tip.

Insert the 4.3mm non cannulated Drill (N02 00015) in the Protecting Sleeve and the Drill Guide. Drill the calcaneus until the calcaneo-cuboid joint line. Control the Drill position with fluoroscopy.

 Care must be taken to stop drilling before the drill enters the cuboid bone.

Read the screw length directly on the Drill over the Drill Guide with the Drill in place in the bone. Make sure the Protecting Sleeve is pressed firmly to the bone before reading screw length.

Remove the Drill and the Drill Guide from the Protecting Sleeve.

Insert the Screwhead Countersink (N02 00021) in the Protecting Sleeve and drill to allow the screwhead to be sunk into the bone. Remove the Screwhead Countersink.

Use the non cannulated T25 Screwdriver (G01 01641) to insert the appropriate length Cotter Screw in the calcaneus.

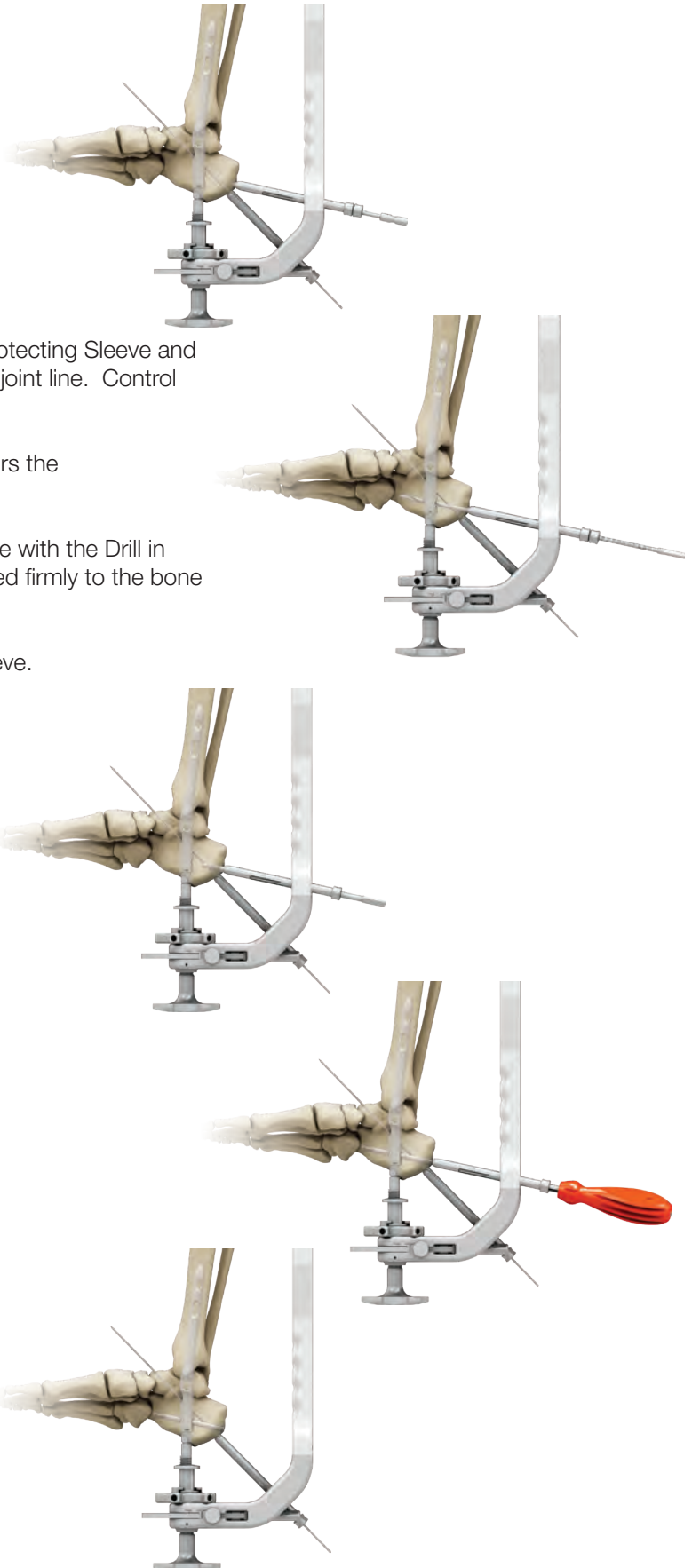

## SUBTALAR COMPRESSION SCREW INSERTION WITH ANTERIOR APPROACH

The subtalar compression screw can either be inserted with a posterior approach or an anterior approach.

In case an **anterior approach** is preferred, be sure the 2.0mm K-wire already inserted in the subtalar joint protrudes from the talar neck in order to insert the cannulated 4.3x275mm Drill (G01 01651). Drill with the cannulated Drill from the talus to the calcaneus over the K-wire.

Direct visualization of the screw length can be read on the cannulated Drill at the bone contact with the cannulated Drill. Remove the Drill.

**!** Remove 5mm from the measurement to select the appropriate screw length as the compression screw will compress the subtalar joint line during its insertion.

A 6.5mm IBS C+ Screw is preferred in order to have a longer threaded portion in the calcaneus.

Insert the appropriate 6.5mm IBS Screw with the cannulated T25 Screwdriver (G01 00411) over the K-wire. Once the screw placement is confirmed with fluoroscopy, remove the K-wire.

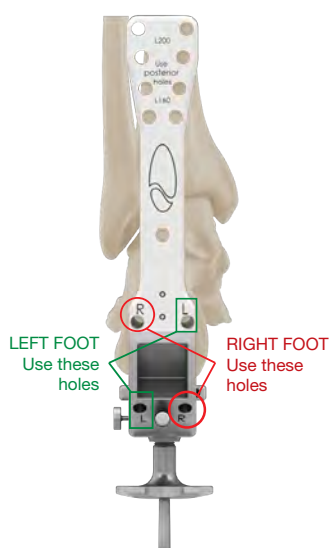
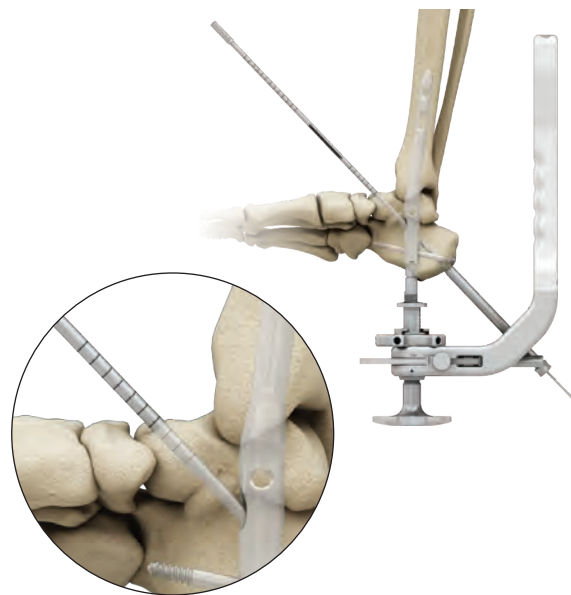

**!** Make sure to select the appropriate hole of the Targeting Jig, according to the operative side.

# TriWay® TTC Arthrodesis System

## SURGICAL TECHNIQUE

### SUBTALAR COMPRESSION SCREW INSERTION WITH POSTERIOR APPROACH

The subtalar compression screw can either be inserted with a posterior approach or an anterior approach.

In case a **posterior approach** is preferred, remove the K-wire Guide while keeping the K-wire in place. Insert the Protecting Sleeve and the Drill Guide into the subtalar screw hole of the Targeting Jig. Take care to have the K-wire located within the Drill Guide.

Insert the cannulated 4.3x275mm Drill (G01 01651) into the Drill Guide and over the K-wire. Drill with the cannulated Drill from the calcaneus to the talus over the K-wire.

Direct visualization of the screw length can be read on the cannulated Drill at the Drill Guide contact with the cannulated Drill. Remove the Drill and the Drill Guide.

 **Remove 5mm** from the measurement to select the appropriate screw length as the compression screw will compress the subtalar joint line during its insertion.

A 6.5mm IBS C Screw is preferred in order to have a shorter threaded portion in the talus.

Insert the appropriate 6.5mm IBS Screw with the cannulated T25 Screwdriver (G01 00411) over the K-wire. Once the screw placement is confirmed with fluoroscopy, remove the K-wire.

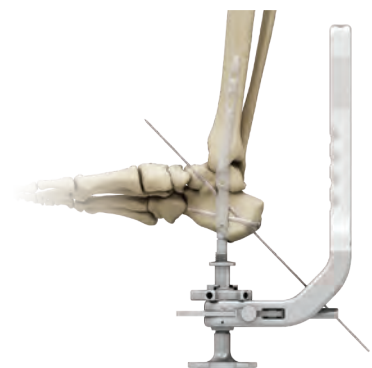
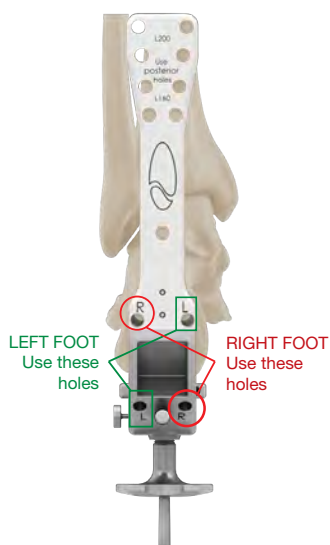
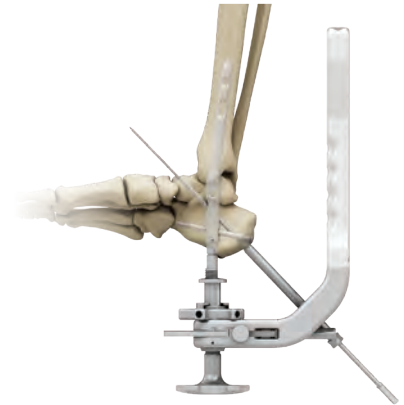

 Make sure to select the appropriate hole of the Targeting Jig, according to the operative side.



## TALAR SCREW INSERTION

The talar screw can either be inserted from a lateral or medial approach based on surgeon preference.

Rotate the Targeting Jig 90° to the desired side by pulling the Index Tab to the « Free » position. Once set, lock the position by pushing the Index Tab to the « Locked » position.

Insert the Protecting Sleeve and the Drill Guide into the talar screw hole of the Targeting Jig.

 Make sure to select the appropriate hole of the Targeting Jig, according to the operative side.

 Make sure that the Sleeve and Drill Guide are in contact with the bone for accurate measurement.

Place the Trocar Tip in the Drill Guide (N02 00026) and puncture the cortex by impacting the Trocar Tip with a mallet. Remove the Trocar Tip.

The screw length can either be read over the 4.3mm non cannulated Drill or with the Depth Gauge (N02 00018). If the Depth Gauge is preferred, remove the 4.3mm non cannulated Drill and the Drill Guide before inserting the Depth Gauge.

Drill with the 4.3mm non cannulated Drill in the Drill Guide. The talar screw must be placed bicortically. Remove the 4.3mm non cannulated Drill.

Remove the Drill Guide from the Protecting Sleeve and insert the Screwhead Countersink. Drill the Countersink to prepare the cortex.

Select the appropriate length Cotter Screw and insert it with the non-cannulated T25 Screwdriver within the Protecting Sleeve.

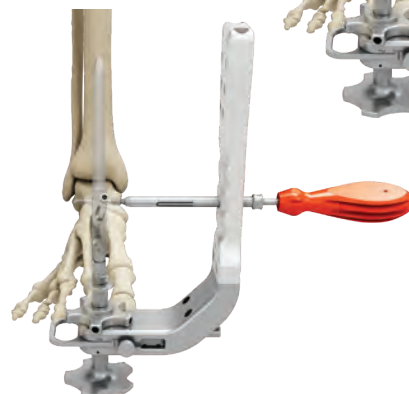
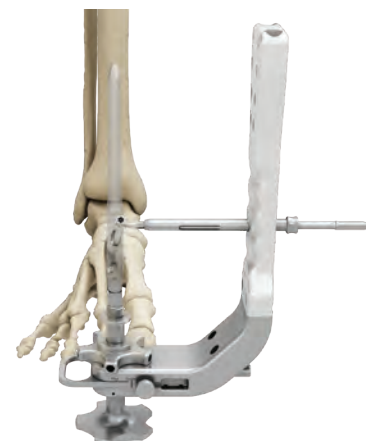
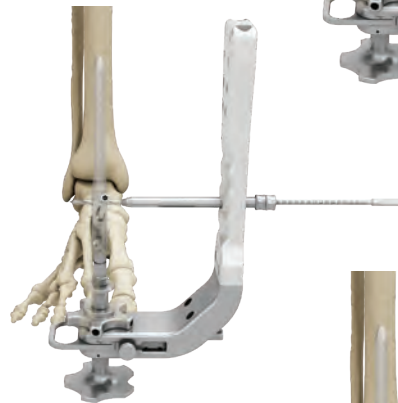

# TriWay® TTC Arthrodesis System

## SURGICAL TECHNIQUE

### TIBIO-TALAR JOINT LINE COMPRESSION

Manual compression is achieved to compress the tibio-talar joint when the distal screws are inserted first.

Manual compression of the tibiotalar joint can be achieved directly by pushing or hammering the Hitting Plate or by using the Slap Hammer.



### TIBIAL SCREWS INSERTION

The Targeting Jig arm is positioned on the lateral or medial side of the tibia according to surgeon preference.

Rotate the Targeting Jig 90° to the desired side by pulling the Index Tab to the « Free » position. Once set, lock the position by pushing the Index Tab to the « Locked » position.

The posterior holes are always used to target the Nail.

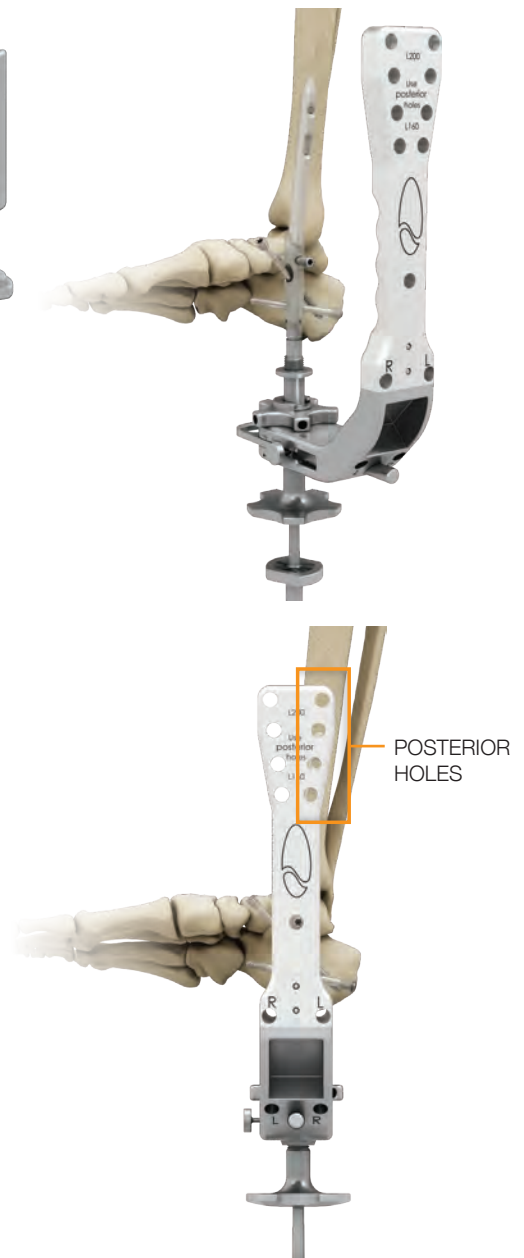

Insert the Protecting Sleeve and the Drill Guide in both of the Targeting Jig arm tibial holes. Be sure to select the appropriate holes according to the size of the Nail inserted in the tibia. For 160mm length Nails use the 2 most distal holes. For the 200mm length Nails use the 2 most proximal holes. For the 250mm Nails free hand targeting will be performed.

Place the Trocar Tip in the most distal Drill Guide and puncture the cortex by impacting the Trocar Tip with a mallet. Remove the Trocar Tip.

 Make sure that the Sleeve and Drill Guide are in contact with the bone for accurate measurement.

 Drill the distal tibial screw hole with the 4.3mm non cannulated Drill in the Drill Guide. Screw length can be read over the 4.3mm non cannulated Drill.

With the Drill still in place in the distal Drill Guide, place the Trocar Tip in the proximal Drill Guide and puncture the cortex by impacting the Trocar Tip with a mallet. Remove the Trocar Tip.

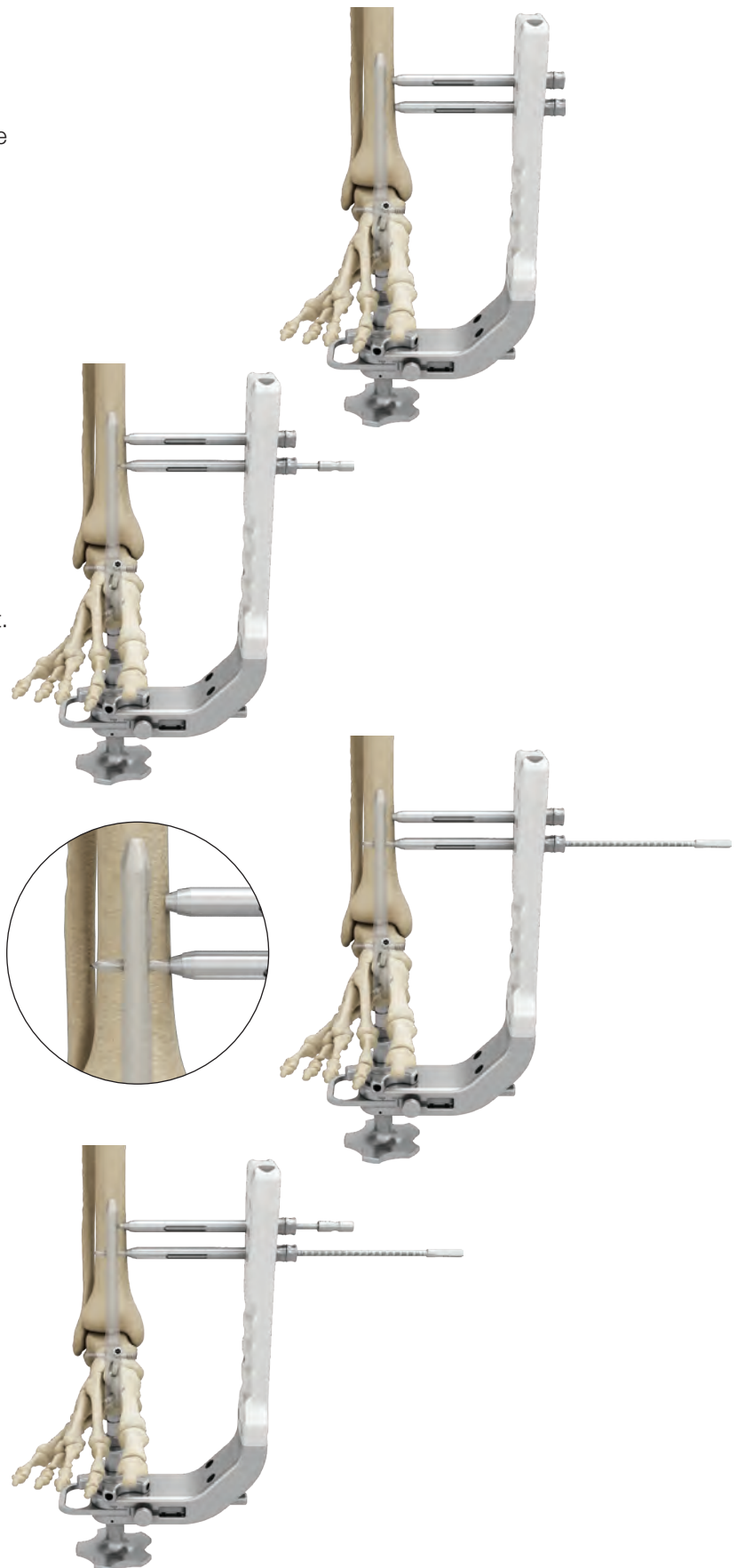

# TriWay® TTC Arthrodesis System

## SURGICAL TECHNIQUE

Remove Drill Bit from the most distal hole. Drill the proximal tibial screw hole with the 4.3mm non cannulated Drill in the Drill Guide. The tibial screw must be placed bicortically. The screw length can be read over the 4.3mm non cannulated Drill.

Remove the Drill Guide from the Protecting Sleeve of the proximal tibial hole and insert the Screwhead Countersink. Drill the Countersink to prepare the cortex.

Select the appropriate length Cotter Screw and insert into in the proximal tibial screw hole within the Protecting Sleeve using the non cannulated T25 Screwdriver.

Remove the Drill Guide from the Protecting Sleeve of the proximal tibial hole and insert the Screwhead Countersink. Drill the Countersink to prepare the cortex.

Select the appropriate length Cotter Screw and insert it into the distal tibial screw hole within the Protecting Sleeve with the non cannulated T25 Screwdriver.

 The tibial screws must be placed bicortically.

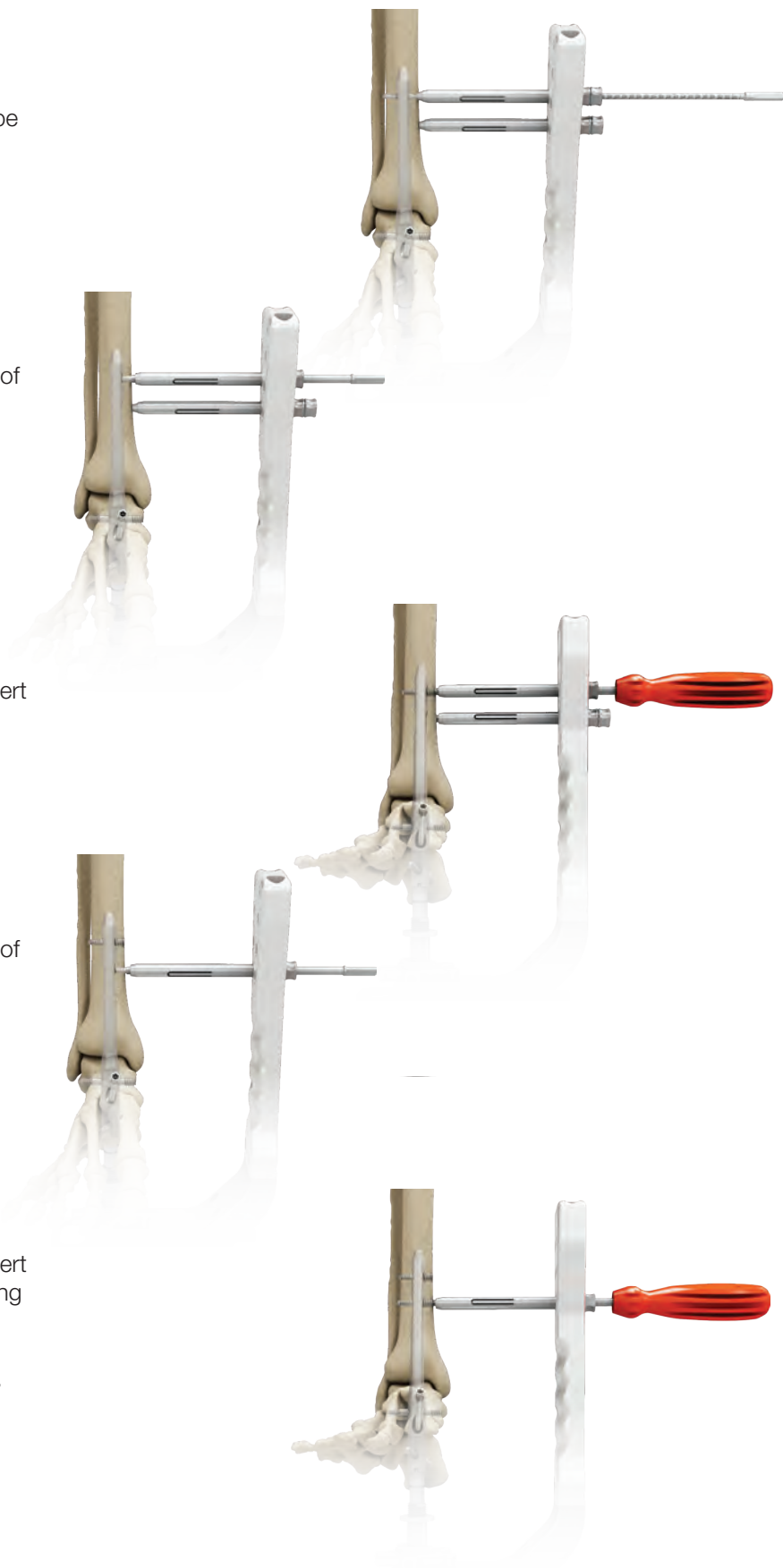

## 8. Nail Fixation and Compression with Proximal Screws Insertion First

Insert the K-wire Guide (N02 0008) into the distal tibial screw hole within the Targeting Jig. Insert K-wire into Guide.

Turn the wheel clockwise to apply compression in the subtalar joint and the tibio-talar joint. Be sure the Nail is not protruding into the calcaneal plantar aspect after compression is achieved.

NAIL POSITION BEFORE COMPRESSION



NAIL POSITION AFTER COMPRESSION

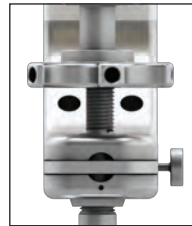

Once compression is achieved, insert the Protecting Sleeve and the Drill Guide within the proximal tibial screw hole within the Targeting Jig arm. Place the Trocar Tip in the proximal Drill Guide and puncture the cortex by impacting the Trocar Tip with a mallet. Remove the Trocar Tip.

Drill the proximal tibial screw hole with the 4.3mm non cannulated Drill in the Drill Guide. The tibial screw must be placed bicortically. The screw length can be read over the 4.3mm non cannulated drill.

Remove the Drill Guide from the Protecting Sleeve of the proximal tibial hole and insert the Screwhead Countersink. Drill the Countersink to prepare the cortex.

Select the appropriate length Cotter Screw and insert it in the proximal tibial screw hole within the Protecting Sleeve with the non cannulated T25 Screwdriver.

Repeat the surgical steps as described previously for the other screws by following the order shown in the illustrations; distal tibial screw, calcaneal screw, subtalar screw, talar screw.

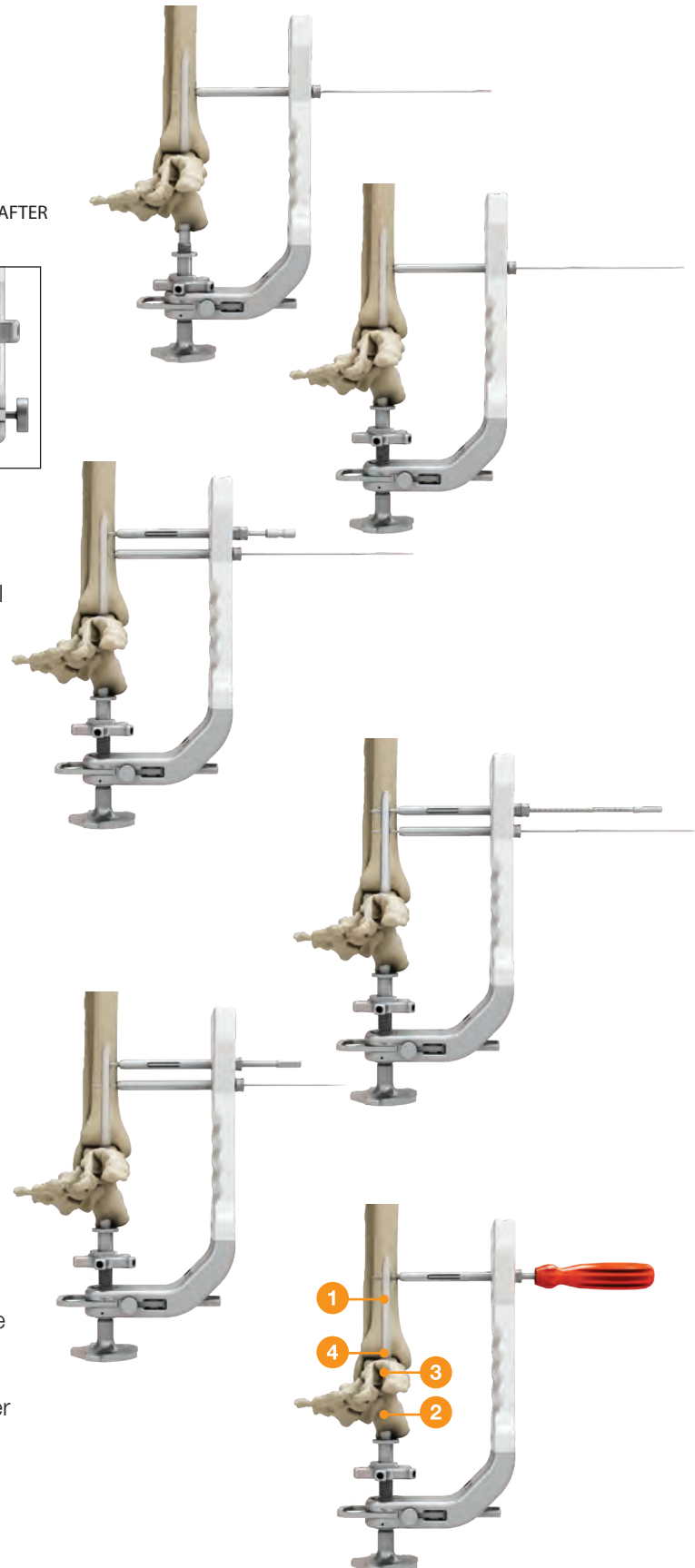

# TriWay® TTC Arthrodesis System

## SURGICAL TECHNIQUE

### 9. Closing and Postoperative Protocol

Confirm hardware placement with AP and lateral X-rays, before detaching the Nail from the Jig. Remove the Jig with the Screwdriver by unscrewing the internal holding Fixation Screw. The wound is closed in layers and the patient is treated with additional fixation if appropriate.

The patient should remain non-weight-bearing for six weeks or until there is early radiographic evidence of consolidation at the arthrodesis sites.

Further protection with a walking boot or brace may help ease the transition to weight bearing.

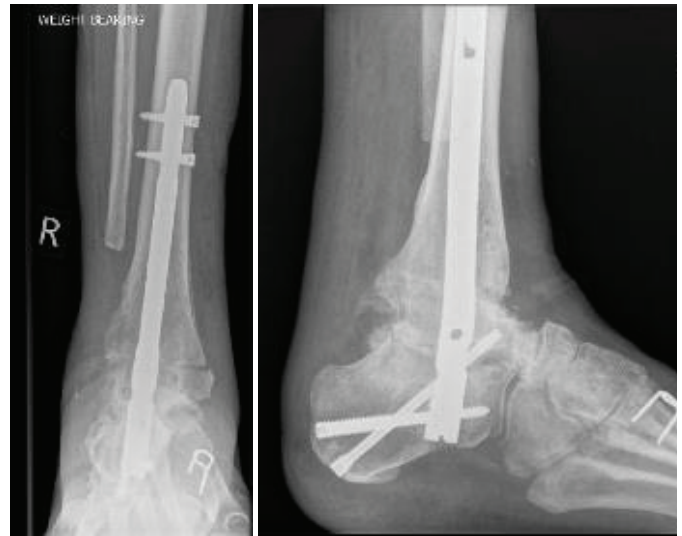

X-rays provided by Stephen Kearns, MD, FRCS (Tr & Orth), Galway University Hospitals

### 10. Revision Technique

Connect the Slap Hammer Guide (N02 00024) to the distal part of the Nail.

Remove all the Cotter Screws with the non cannulated T25 Screwdriver, starting from proximal to distal. In case a Cotter Screw is locked in the bone, use the Screw Extractor (N02 00019). Screw the Screw Extractor over the Cotter Screw's head and pull on the Screw Extractor, or use the non cannulated T25 Screwdriver to remove the Cotter Screw.

Confirm with fluoroscopy if the subtalar screw has been inserted from anterior or posterior. Insert the 2.0mm K-wire in the subtalar screw. Remove the subtalar 6.5mm IBS Screw with the cannulated T25 Screwdriver.

Once all screws have been removed, place the Slap Hammer Mass (N02 00025) over the Slap Hammer Guide and gently extract the Nail by hitting on the Slap Hammer.

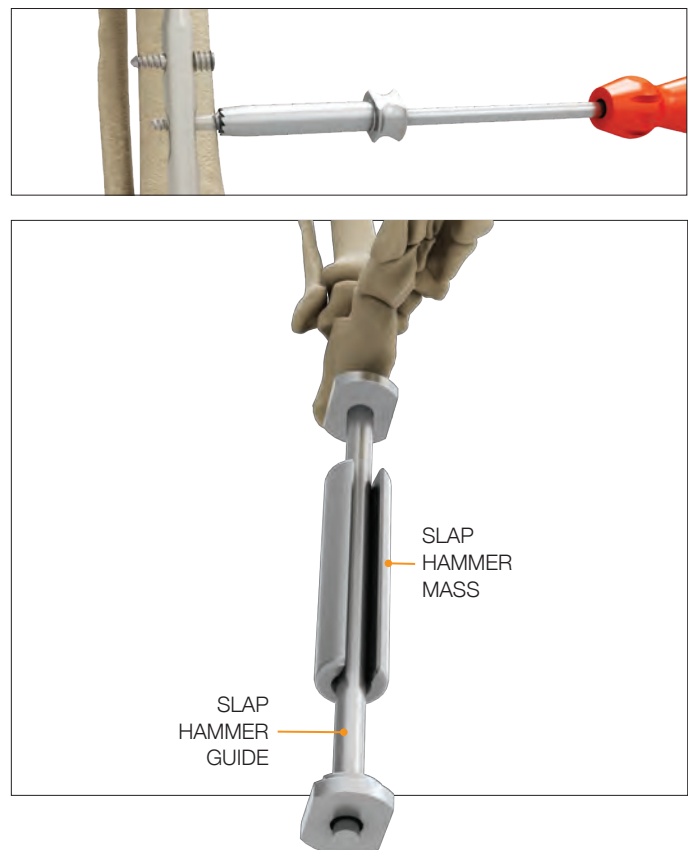

# ORDERING INFORMATION

## TriWay® Arthrodesis Nails / Sterile

PART#	DESCRIPTION	RIGHT / LEFT
N20 ST101..	10mm Lg..	160mm..R
N20 ST201..	10mm Lg..	160mm..L
N20 ST102..	10mm Lg..	200mm..R
N20 ST202..	10mm Lg..	200mm..L
N20 ST111..	11mm Lg..	160mm..R
N20 ST211..	11mm Lg..	160mm..L
N20 ST112..	11mm Lg..	200mm..R
N20 ST212..	11mm Lg..	200mm..L
N20 ST113..	11mm Lg..	250mm..R
N20 ST213..	11mm Lg..	250mm..L
N20 ST121..	12mm Lg..	160mm..R
N20 ST221..	12mm Lg..	160mm..L
N20 ST122..	12mm Lg..	200mm..R
N20 ST222..	12mm Lg..	200mm..L
N20 ST123..	12mm Lg..	250mm..R
N20 ST223..	12mm Lg..	250mm..L

## TriWay® Cotter Screws / Sterile

PART#	DESCRIPTION
N20 ST525...	5.0mm Lg. ....25mm
N20 ST530...	5.0mm Lg. ....30mm
N20 ST535...	5.0mm Lg. ....35mm
N20 ST540...	5.0mm Lg. ....40mm
N20 ST545...	5.0mm Lg. ....45mm
N20 ST550...	5.0mm Lg. ....50mm
N20 ST555...	5.0mm Lg. ....55mm
N20 ST560...	5.0mm Lg. ....60mm
N20 ST565...	5.0mm Lg. ....65mm
N20 ST570...	5.0mm Lg. ....70mm
N20 ST575...	5.0mm Lg. ....75mm
N20 ST580...	5.0mm Lg. ....80mm
N20 ST585...	5.0mm Lg. ....85mm
N20 ST590...	5.0mm Lg. ....90mm

## IBS® C 6.5mm Sterile Compression Screw

PART#	DESCRIPTION
S65 ST160...	6.5mm Lg. .... 60mm
S65 ST165...	6.5mm Lg. .... 65mm
S65 ST170...	6.5mm Lg. .... 70mm
S65 ST175...	6.5mm Lg. .... 75mm
S65 ST180...	6.5mm Lg. .... 80mm
S65 ST185...	6.5mm Lg. .... 85mm
S65 ST190...	6.5mm Lg. .... 90mm

## IBS® C+ 6.5mm Sterile Compression Screw

PART#	DESCRIPTION
S65 ST560...	6.5mm Lg. .... 60mm
S65 ST565...	6.5mm Lg. .... 65mm
S65 ST570...	6.5mm Lg. .... 70mm
S65 ST575...	6.5mm Lg. .... 75mm
S65 ST580...	6.5mm Lg. .... 80mm
S65 ST585...	6.5mm Lg. .... 85mm
S65 ST590...	6.5mm Lg. .... 90mm

# INSTRUMENT SET

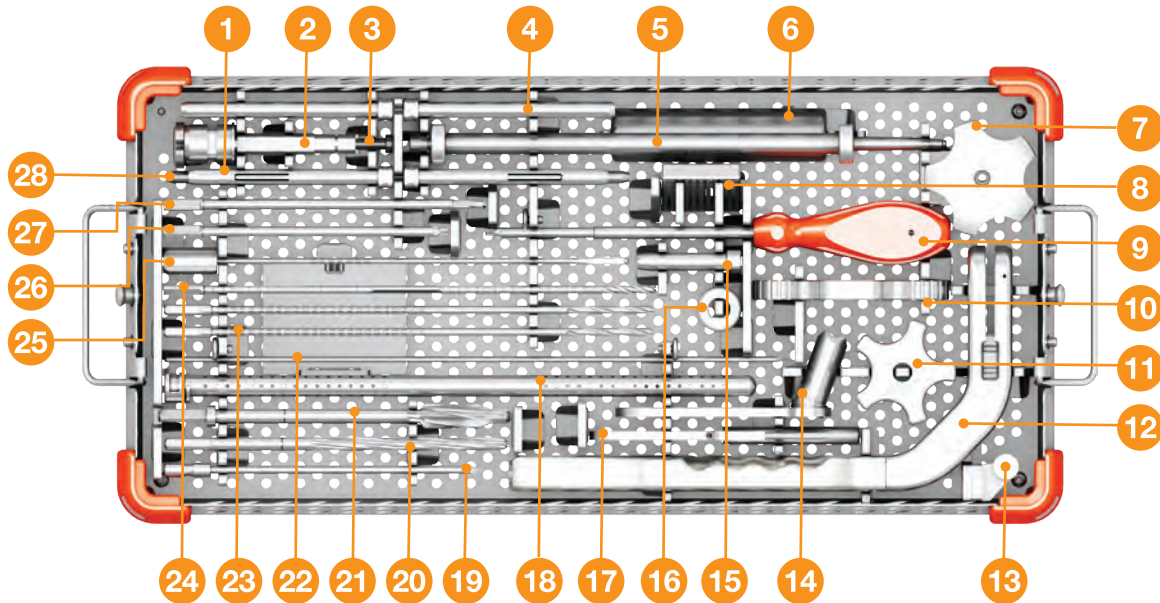

PART NUMBER	DESCRIPTION	QUANTITY
<b>1</b>	N02 00013	Protecting Sleeve..... 2
<b>2</b>	N02 00003	Connector ..... 1
<b>3</b>	N02 00004	Fixation Screw ..... 1
<b>4</b>	N02 00008	Guide Guide for 2.0mm Dia K-wire ..... 2
<b>5</b>	N02 00024	Slap Hammer Guide ..... 1
<b>6</b>	N02 00025	Slap Hammer Mass ..... 1
<b>7</b>	N02 00011	Hitting Plate ..... 1
<b>8</b>	N02 00023	Tibio Talar Cutting Guide..... 1
<b>9</b>	G01 00411	T25 Screwdriver Cannulated..... 1
<b>9</b>	G01 01641	T25 Screwdriver Non Cannulated ..... 1
<b>10</b>	G01 01391	"T" Handle For Medium Screwdriver ..... 1
<b>11</b>	N02 00009	Compression Wheel..... 1
<b>12</b>	N02 00001	Targeting Jig ..... 1
<b>13</b>	N02 00020	Index Lock..... 1
<b>14</b>	N02 00006	Soft Tissue Protector..... 1
<b>15</b>	N02 00019	Screw Extractor..... 1

PART NUMBER	DESCRIPTION	QUANTITY
<b>16</b>	N02 00010	Compression Sleeve ..... 1
<b>17</b>	N02 00005	Index Tab ..... 1
<b>18</b>	G01 40041	K-wire Tube ..... 1
<b>18</b>	N02 00017	2.0mm Dia K-wire Lg 300mm ..... 3
<b>18</b>	K10 NS200	2.5mm Dia K-wire Lg 200mm 1 Sharp Tip Non Sterile ..... 1
<b>18</b>	K10 NS251	2.5mm Dia K-wire Lg 100mm 1 Sharp Tip Non Sterile ..... 4
<b>19</b>	N02 00026	Trocar Tip 4.3mm Dia ..... 1
<b>20</b>	N02 00027	7.0mm Dia Cannulated Drill ..... 1
<b>21</b>	N02 00016	14.0mm Dia Cannulated Reamer..... 1
<b>22</b>	N02 00014	3.2mm X 350mm Guide Wire..... 2
<b>23</b>	N02 00015	4.3mm Non Cannulated Drill ..... 2
<b>24</b>	G01 01651	4.3mm x 275mm Cannulated Drill (use over 2.0mm K-wire)..... 1
<b>25</b>	N02 00018	Depth Gauge ..... 1
<b>26</b>	G01 01591	T25 Screwdriver Tip Cannulated K-wire 2.0mm ..... 1
<b>27</b>	N02 00021	Screwhead Countersink..... 1
<b>28</b>	N02 00007	4.3mm Drill Guide..... 2

# TriWay® TTC Arthrodesis System

## TibioTaloCalcaneal Arthrodesis System

### Regulatory information

#### RECOMMANDATION

It is recommended to carefully read the instructions for use available in the package insert.

#### REIMBURSEMENT

Reimbursement may vary from country to country. Check with local authorities.

#### MANUFACTURER

In2Bones SAS  
28, chemin du Petit Bois  
69130 Ecully – FRANCE  
Tél : +33 (0)4 72 29 26 26  
Fax : +33 (0)4 72 29 26 29

#### DOCUMENT

Reference : ST-DIG-TRIWAY-EN-032019

Availability of these products might vary from a given country or region to another, as a result of specific local regulatory approval or clearance requirements for sale in such country or region.

Always refer to the appropriate instructions for use for complete clinical instructions.

Non contractual document. The manufacturer reserves the right, without prior notice, to modify the products in order to improve their quality.

**CAUTION:** Federal law (USA) restricts this device to sale and use by, or on the order of a physician.

Except otherwise specified, all commercial trademarks used in this document, In2Bones and the In2Bones logo are trademarks or registered trademarks of In2Bones or its subsidiaries.

EC Classification (EC Directive MDD 93/42/EC):

Implant: CE Class IIb - CE2797

Instruments connected to a power driver: class IIa - CE2797

Instrument with measuring function: Class Im - CE2797

Other instruments: Class I - CE

ST-DIG-TRIWAY-EN-032019

PATENT PENDING



A GLOBAL EXTREMITY COMPANY  
In2Bones.com

#### International Office

In2Bones SAS • 28, chemin du Petit Bois • 69130 Ecully • FRANCE  
**+33 (0)4 72 29 26 26** • [Contact@In2Bones.com](mailto:Contact@In2Bones.com)

#### Corporate Headquarters

In2Bones Global, Inc. • In2Bones USA • Memphis, TN • USA  
**844. 602. 6637** • [Info@i2b-USA.com](mailto:Info@i2b-USA.com)

In2Bones® as the manufacturer of this device, does not practice medicine. The surgeon who performs any implant procedure is responsible for determining and using the appropriate surgical techniques for implanting the device in each patient. This Surgical Technique Manual is furnished for information purposes, as an aid to use properly the device and its dedicated instruments. • TriWay, the In2Bones name and logo are trademarks or registered trademarks of i2b-USA or its subsidiaries.  
© 2019 In2Bones, Memphis, TN - All rights reserved  
ST-DIG-TRIWAY-EN-032019